

TRAMPER™



DIRT - E - TRIKE USER MANUAL

Please note that this manual is a live document and currently still in progress. Please follow all the instructions to the best of your ability as we continue to update the manual with more relevant information and diagrams.

VESC®
TOOL

Welcome to the Trampa Dirt-E -Trike Manual!

The Dirt-E-Trike is a well refined and an undoubtedly fun product. Please make sure to read and understand **ALL THE INFORMATION** included in this manual, before riding. This will help you to get the most out of your trike and keep you tearing up the trails!

We have put together a series of videos explaining many of the steps and information outlined in this manual. Click the titles labelled "VIDEO" to be directed to the relevant video on YouTube.

[Full length Dirt-E-Trike Assembly Video](#)

Contents

DIRT - E - TRIKE USER MANUAL	0
Welcome to the Trampa Dirt-E -Trike Manual!	1
Contents	2
Warning Message	4
Getting Started	5
Tools for Initial Assembly	5
Recommended Tools & Items for Full Maintenance:	5
Additional Tools for Assembling 18650 or 21700 Packs:	5
Removing the Original Rear Frame	6
Installing the Replacement Rear Frame	6
Installing the Spur Gear Drive to the Rear Frame	6
Installing the Wheelie Bar	7
Battery Installation	8
Example of 2x 6S 20Ah LiPo Batteries	8
Example of 84x 21700 Li-Ion Cells	8
LiPo Packs	9
18650 / 21000 Cells	10
Installing the Monster Box Battery Enclosure	11
Routing the Throttle and Brake Cables	11
Setting up the Handle Bars	13
Installing the Throttle and Brake	14
VESC Tool	15
Connect to the VESC	15
Motor Setup Wizard	16
Throttle & Brake Setup	18
Custom Profiles	19
Battery Charging & Storage	20
Battery Warning	20
LiPo Charging	21
Lithium Battery Voltages	21
Recommended Charge Current (Amps)	21
18650 / 21000 Cell Charging	23
Lithium Battery Voltages	23
Maintenance	25
General	25
Tightening of Bolts - Bolts to Check!	25
Cleaning the Trike	26
Drivetrain Health	26
Wheels	27
Changing a Tyre or Inner Tube	27
Tyre Pressure	27
Spur Gear Drive	28

Maintaining the Gears	28
Adjusting Backlash/ Meshing of Gears	30
Li-Ion & LiPo Battery Care & Safety information	31
Lithium-Ion Battery Hazards	31
Li-Ion & LiPo Battery Usage	31
Procurement	31
Handling and Use	31
Charging	32
Discharging	32
Storage	32
Disposal	33
Prohibited	33
What to do in an Emergency	33
Warranty Policy	34
Warranty	34
Claims	34
Warranty Periods	34
Claim Procedure	35
Contact	37

Warning Message

RIDING THE DIRT-E-TRIKE CAN BE VERY DANGEROUS!

E-Triking, E-Boarding or any type of sport associated with TRAMPA BOARDS LTD products is inherently dangerous. If Trampa products are misused/used against our guidance, the consequences could result in serious injury or death.

Full body protection is highly recommend, which includes a fully functioning strong/certified helmet, with face guard if possible, wrist, elbow, and knee pads

SAFE RIDING TIPS

1. Never ride near roads, cars or traffic of any kind.
2. Before riding, inspect the terrain for obstacles and remove any potentially hazardous items from your route.
3. Make sure you inspect your board before riding. Ensure everything is tight and functioning correctly before use.
4. Never ride worn out or broken/damaged equipment.
5. Make sure to use the latest VESC-Tool and firmware.
6. Use the VESC-Tool profiles to adjust the max speed and power to your skill level.
7. Don't overestimate yourself, stay on the safe side.

If you have any doubts, get in touch with us!
SUPPORT@TRAMPABOARDS.COM

Getting Started

Tools for Initial Assembly

Torx: T20

Hex / Allen Key: 2.5, 4, 6mm

Sockets / Spanners: 10, 13, 16mm

Heat Gun

Sidecutters



Recommended Tools & Items for Full Maintenance:

Torx: T10, T20, T25, T30

Hex / Allen Key: 2, 2.5, 3, 4, 5, 6mm

Spanners / Sockets: 6, 7, 8, 10, 12, 14, 16mm

Blue Loctite 243

EP3 Lithium Grease

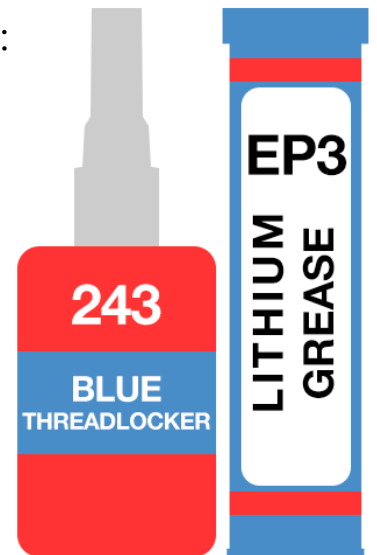

Additional Tools for Assembling 18650 or 21700 Packs:

Multimeter

Isopropyl Alcohol

Ruler

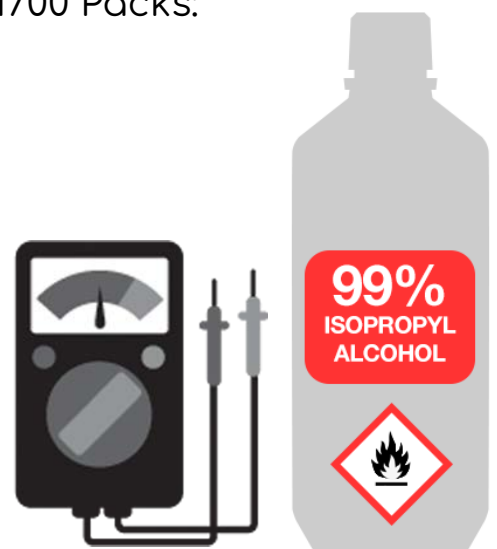

Removing the Original Rear Frame

1. Firstly undo the seat quick release clip
2. Slide the seat all the way forward so that the seat is out of the way
3. Using the 13mm socket and spanner remove the three M8 bolts holding the rear section of the frame onto the main frame
4. Remove the rear frame from the main frame by lifting it upwards

Installing the Replacement Rear Frame

1. Place the new rear frame onto the main section of the frame ensuring that all three mounting holes line up with the original frame
2. Using the three M8 high tensile bolts provided in the conversion kit, a 6mm allen key, and a 13mm spanner, attach the replacement rear frame to the main frame using the original mounting holes

Installing the Spur Gear Drive to the Rear Frame

1. In the kit are two pre-assembled Spur Gear Drives (SGD) with axles already installed. One is the left side and one the right side. Slide the axles into the 25mm box section with the motor facing backwards and SGD bashguard at the bottom.
2. Place three M8 x 50mm hex bolts with M8 washers through the rear frame and into the top of each axle and tighten with a 13mm socket or spanner.
3. On the bottom of the axle place an M8 flange nut on the remaining thread and tighten using a 13mm socket or spanner.

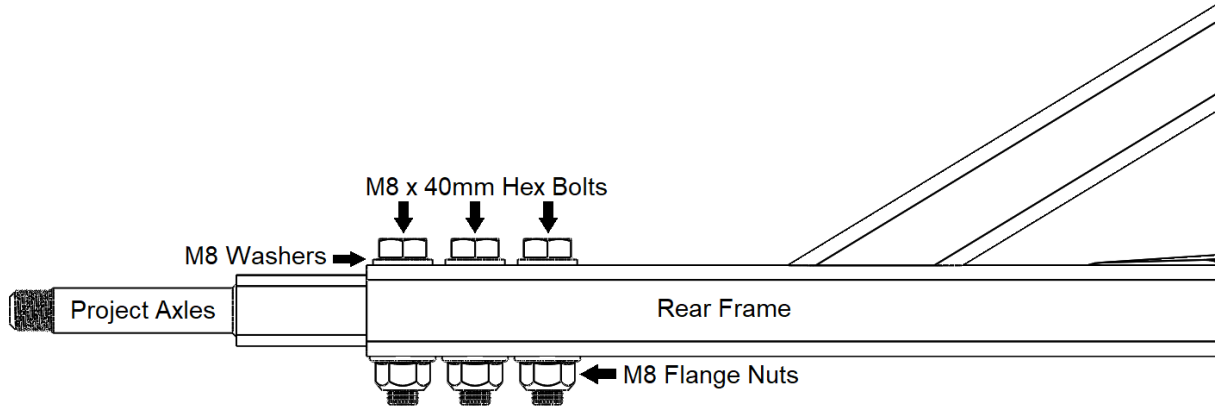

Installing the Wheelie Bar

1. Place a M8 washer onto the kingpin and put the kingpin through the hole in one arm of the wheelie bar followed by a 20.5mm spacer.
2. Continue pushing the kingpin through the bearings on the stickies wheel and put another 20.5mm spacer onto the kingpin before going through the other wheelie bar arm.
3. Place a M8 washer over the final shoulder of the kingpin and then an M6 nyloc nut.
4. Using a 10mm socket and a 4mm Allen key tighten the kingpin.
5. Spin the wheel to ensure that it spins freely - loosen the nut if it does not spin freely.

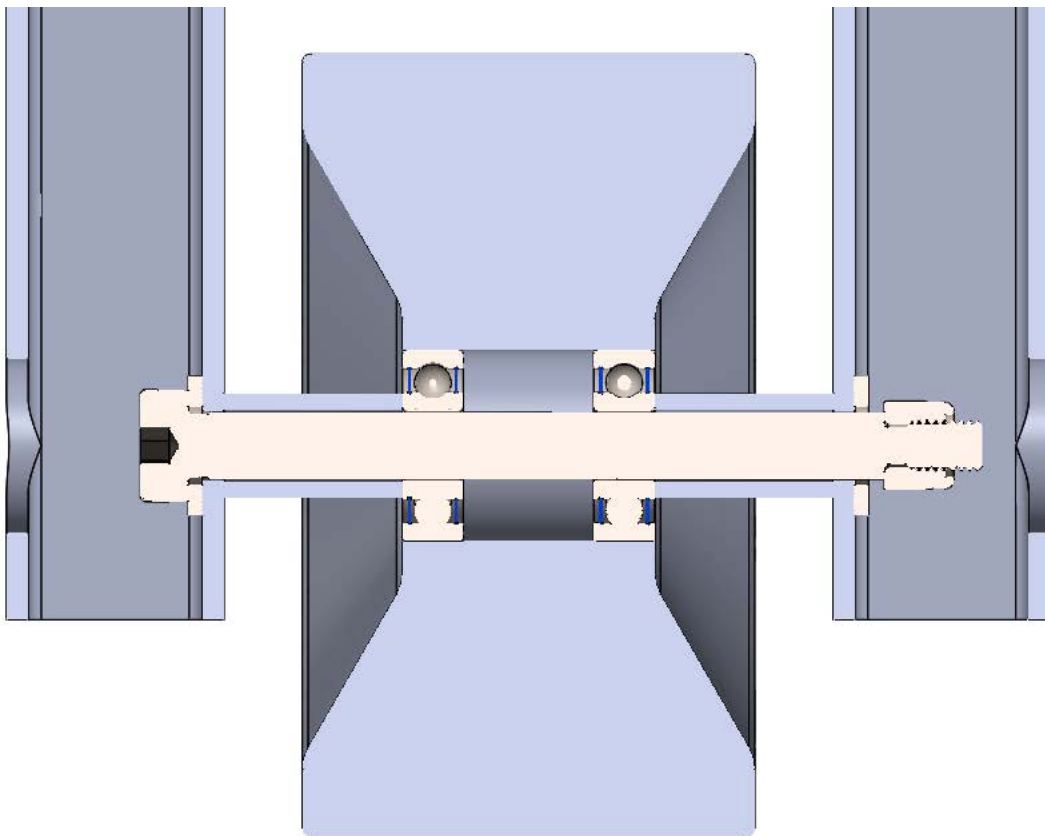

Battery Installation

We currently offer three types of battery options, LiPo Packs and Li-Ion Cells (18650 & 21700). Please follow the manual accordingly.

Please take caution while proceeding with this step. Rechargeable Lithium-ion polymer batteries are potentially hazardous and can present a serious FIRE HAZARD, SERIOUS INJURY and/or PROPERTY DAMAGE if damaged, defective or improperly used.

[READ MORE DETAIL HERE](#)

Recommended Battery

	LiPo Packs	Li-Ion Cells
Classic Monster Box	4x 6S 6.2Ah Packs* 2x 6S 20Ah Packs	84x 18650 Cells
Massive Monster Box	2x 6S 22Ah Packs *Extra cable required	84x 21700 Cells



Example of 2x 6S 20Ah LiPo Batteries



Example of 84x 21700 Li-Ion Cells

1. Remove the lid of the battery box using a T20 screwdriver.
2. Place opposite sides of Velcro on both the base of the box and the LiPo cell.
3. Place the LiPo Packs down into the box making sure no wires are being trapped or strained.
4. Check the LiPos are firmly in place. We recommend 'packing out' the box with foam tape on the lid and/or edge panels to eliminate any movement of the Lipo Packs.
5. Connect the XT90 connectors from the batteries into the wire harness, then plug the two remaining XT90 connectors into the VESCs as shown.
-Please double check against the diagram before plugging in.
-Incorrect wiring can result in damage to equipment or injury.
6. Feed the balance connectors and XT30 connector through the grommets into the top of the inspection bay.
7. Carefully, place the lid of the box back on, ensuring no wires are being trapped or strained.
8. Align the edge panels with the slots of the lid before going round and evenly tightening the bolts.

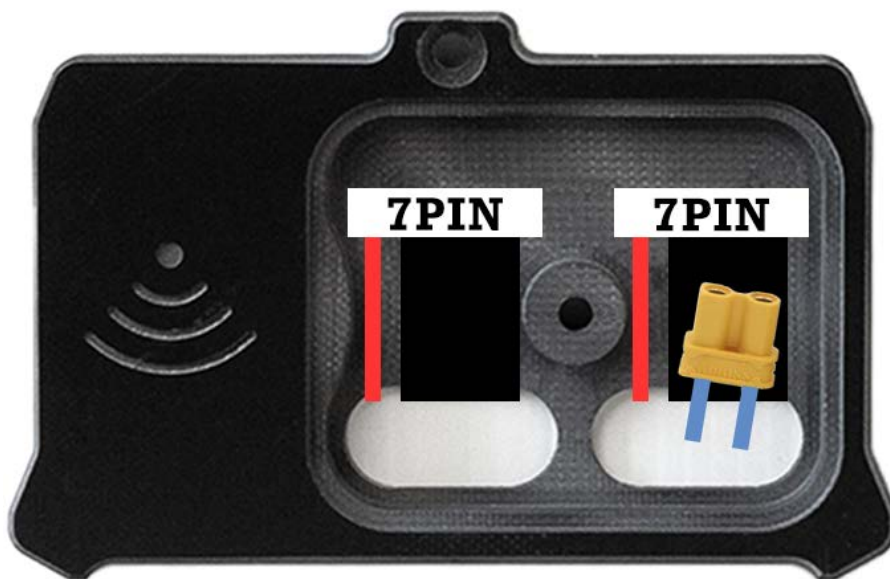

Inspection Pit - LiPo Pack

18650 / 21000 Cells

[18650 VIDEO](#)
[21700 VIDEO](#)

It is **HIGHLY RECOMMENDED** you follow the video tutorial we have made when assembling these packs. Click 'VIDEO', or go to Trampa Boards Youtube channel to find these videos.

Supplied inside the battery box, will be a separate manual also explaining the assembly and set up for the 18650 and 21000 Cell Packs. [CLICK ME](#) to find a copy of this manual.

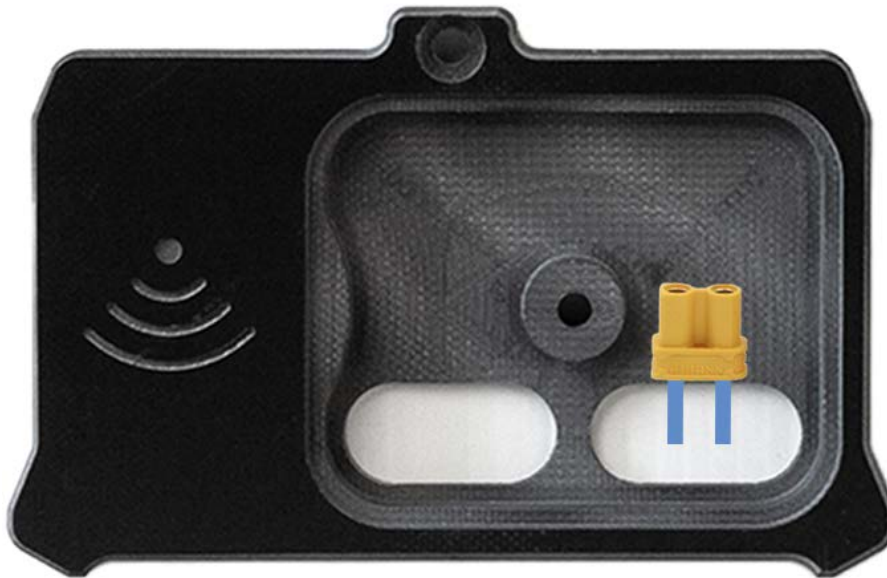

Inspection Pit - 18650 / 21700 Cell Packs

Installing the Monster Box Battery Enclosure

1. Using the three M6x45mm bolts and a 4mm Allen key secure the Monster Box dogbone to the rear central upright as shown.
2. Place the wide heat shrink over the motor extension cable followed by 6 mm heatsink over the bullet connects.
3. Connect the bullet connectors to the motor extension cables and slide the 6mm over the connectors.
4. Using a heat gun shrink the 6mm heat shrink over the connectors
5. Slide the wide heat shrink over the rest of the phase wires and shrink it with the heat gun to tidy all the phase wires together.
6. Using 9mm heat shrink connect the sensor wires JST connectors and shrink the hearing over the connectors
7. Plug the throttle and brake connectors into the top of the monster box as labelled.

Routing the Throttle and Brake Cables

1. Using a 4mm allen key and 10mm socket loosen two of the bolts connecting the seat pan to the seat mount.
2. Run the throttle and brake cable extensions under the seat and secure them with cable ties as pictured.
3. Run the remainder of the cable extension up the frame of the trike and split the connectors at the top so that the connector labelled throttle is on the right hand side and brake on the left.

Setting up the Handle Bars

1. Using a 6mm allen key loosen the two bolts clamping the stem onto the headtube and the four bolts holding the handlebars onto the stem.
2. Rotate the handle bars 180 degrees around the headtube and spin the handle bars so they are swept towards the seat.
3. Align the handlebars with the front wheel and tighten the six previously loosened bolts.



Installing the Throttle and Brake

1. Using a 4mm Allen key remove the screw from the throttle and brake clamps and open the clamp.
2. Place the brake on the left handlebar and throttle on the right handlebar and tighten the clamp.
They can be later adjusted to a more comfortable position.
3. Connect the throttle and brake connectors as labelled and cable tie with enough slack so that the front wheel and handlebars can rotate 180 degrees.

VESC Tool

[VIDEO](#)

To start you'll need to get the VESC Tool software on a platform you have available to you.

The VESC Tool is available on iOS, Android, and desktop versions (Windows, Linux).

It is recommended to download the VESC Tool on a mobile device for on the go adjustments or troubleshooting.



Please scan one of the following QR codes to download the VESC tool.

You will use this tool for programming, tuning, and diagnosing your board, so get used to using it!

Connect to the VESC

1. Ensure Bluetooth is enabled on your device
2. Turn on the board by pressing the switch on the Monster Box
3. Open the VESC Tool App on your device
4. Press "SCAN" if no devices are showing up
5. Press "CONNECT" to then connect to the NRF

The NRF can also be saved as a preferred device and renamed. This is highly recommended for convenience and safety purposes, when multiple devices may be showing up.

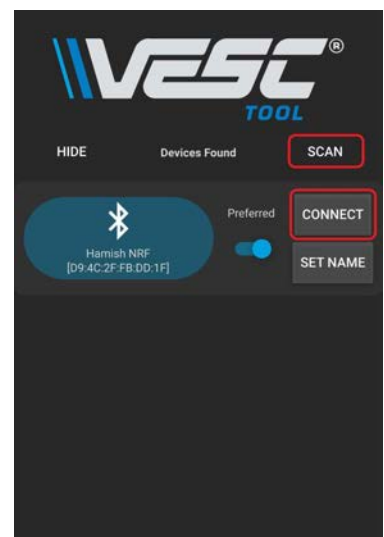

Motor Setup Wizard

[VIDEO](#)

WARNING - Place board on a raised surface while using the VESC Tool.
Setting up the motors requires the motors and wheels to spin.

1. Connect to the VESC via NRF/Bluetooth
2. Click the "Setup Motor" Button
3. Click "YES" to Load Default Parameters
4. Select "E-Skate" ensuring that the Duty Cycle Current Limit Start has changed to 85%, followed by pressing the "Next" button.

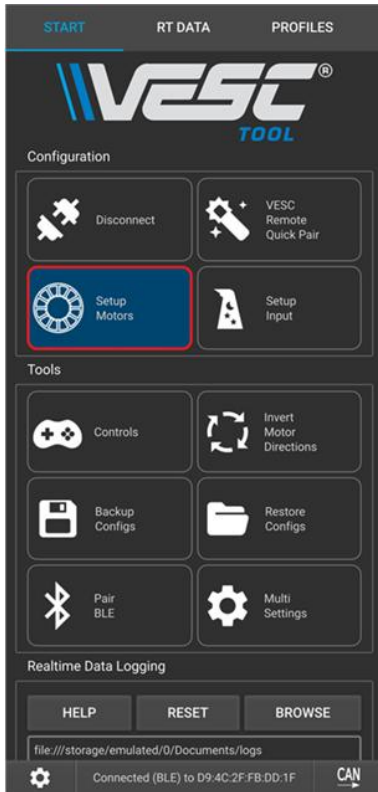

STEP 2

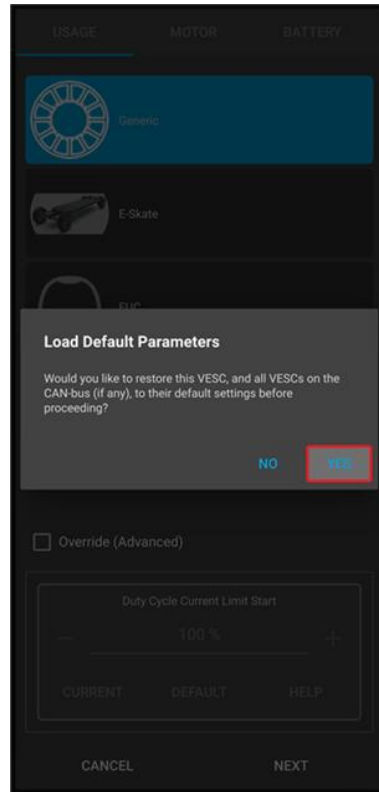

STEP 3

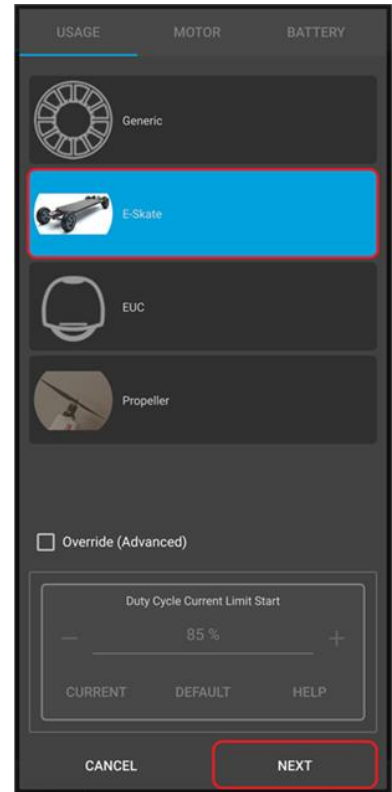

STEP 4

5. Select “Medium Outrunner”, followed by pressing “NEXT”.
6. Battery settings are dependent on which battery option you have selected - Ensure these details are correct to prevent damage to the VESC(s) or the battery.
7. Adjust the Motor Pulley, Wheel Pulley and Wheel Diameter according to your board’s specification - Specifications can be on the Quick Start Guide supplied with your board.



STEP 5

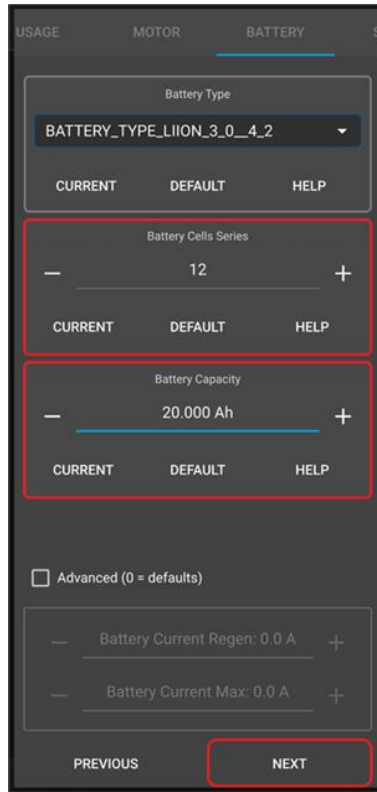

STEP 6

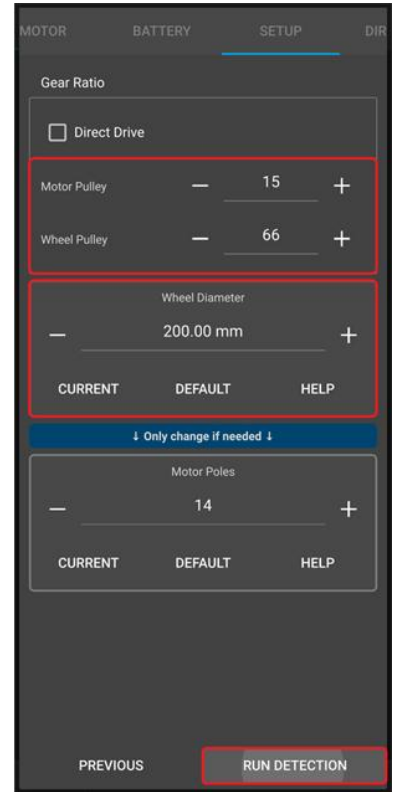

STEP 7

8. Select “Detect all motors over CAN Bus”, followed by “OK” which will then begin to spin the motors.
9. A results screen will appear, press continue.
10. The wheel direction can now be tested and swapped if necessary.
11. Press finish to complete the set up.

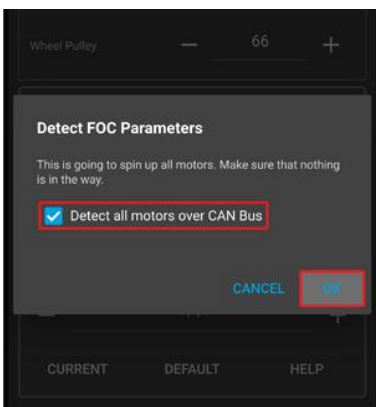

STEP 8



STEP 9



STEP 10

Throttle & Brake Setup

Custom Profiles

Within the VESC Tool you are able to set up custom profiles enabling different speed, braking and acceleration settings.

1. Open the "Profiles" tab
2. Press "Add Profile"
3. Here you are able to name the profile and adjust the speed to your requirements*

*Please note that the max speed of your board is only as fast as the hardware allows. The max speed in the VESC Tool can be set higher but your board may not reach these speeds.

Please DO NOT adjust the Motor Current Scale settings unless you are familiar with the VESC Tool or have been advised to do so by a member of the support team.

Battery Charging & Storage

Battery Warning

Rechargeable Lithium-ion polymer batteries are potentially hazardous and can present a serious FIRE HAZARD, SERIOUS INJURY and/or PROPERTY DAMAGE if damaged, defective or improperly used.

READ and UNDERSTAND the CHARGER MANUAL before proceeding.

NEVER leave a battery charging unattended

NEVER charge a battery if it is damaged

NEVER charge a battery if you are having problems or suspect something may be wrong

NEVER charge a battery directly after it has been drained. - ensure the battery has had sufficient time to cool.

ALWAYS use the appropriate charger and settings.

In the event of an EMERGENCY, ALWAYS CONTACT YOUR LOCAL EMERGENCY SERVICES.

[PLEASE READ MORE DETAIL HERE](#)

LiPo Charging

[VIDEO](#)

We recommend that you use the ULTRA POWER Charger pictured below. Alternative LiPo balance chargers can also be used.*

*Please ensure you have read the manual for your specific charger and you are familiar with how to use the charger correctly before continuing. We hold NO RESPONSIBILITY for incorrect use of a charger.



ULTRA POWER CHARGER

Lithium Battery Voltages

	1 Cell (1S)	12 Cells (12S)
0%	3.00V	36.00V
Recommended minimum	3.35V	40.20V
Storage	3.80V	45.60V
100%	4.20V	50.40V

Recommended Charge Current (Amps)

Battery Capacity	Recommended	Maximum
1Ah (example)	0.5A	1A
12.4Ah	5A	10A
20Ah	10A	15A
22Ah	10A	15A

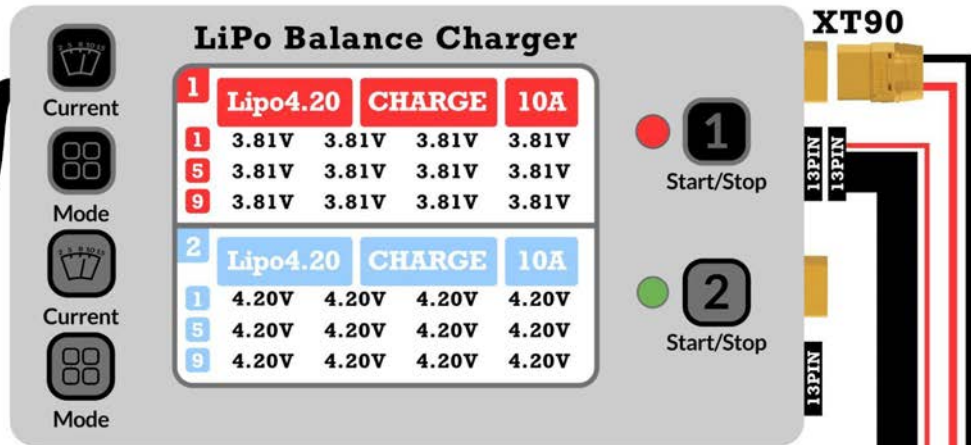

1. PLUG IN and TURN ON the CHARGER BEFORE connecting any batteries to the charger.
2. Press MODE so the charger is in CHARGE MODE. - Other chargers may require you to select 'Balance Charge'.
3. We recommend setting the AMPS to 10A, or 15A for a fast charge. - Whenever possible we recommend using 10A to avoid reducing the batteries lifespan.
4. Remove the THUMB SCREW and INSPECTION PIT LID on the top of MONSTER BOX.
5. PLUG the XT30 EXTENSION from the charger into the XT30 inside the INSPECTION PIT.
6. PLUG the BALANCE EXTENSIONS from the BALANCE PCB into the BALANCE CABLES inside the INSPECTION PIT.
7. HOLD the "START/STOP" or "CHARGE" button to proceed with CHARGING.
8. NOTE - If the charger BEEPS or displays "CONNECTION ERROR", swap the balance cables over as seen in the figure labelled "Balance Swap".
9. Once the battery is CHARGED the charger will BEEP and the LED will be GREEN.
10. PRESS the "START/STOP" button and unplug all the cables from the board.
11. Tuck the BALANCE CABLES back into the inspection pit, and place the LID back on ensuring no cables have been trapped.
12. Put the THUMB SCREW back on and tighten.
13. Turn OFF the CHARGER and UNPLUG from the wall.

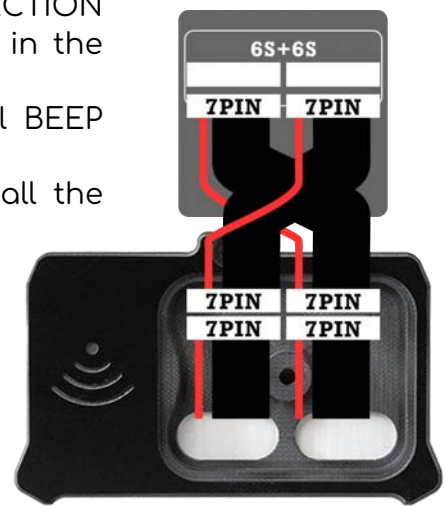
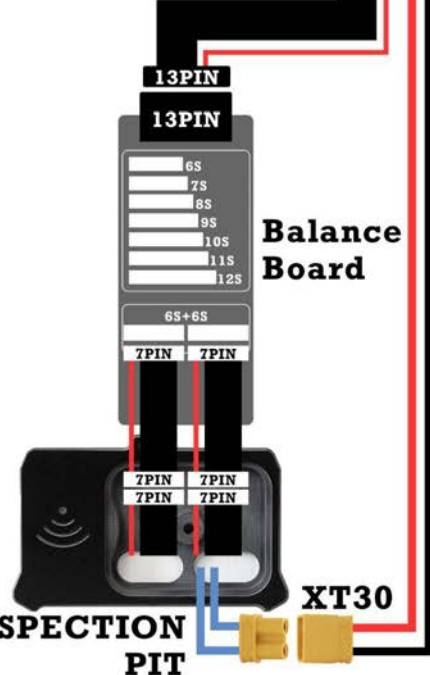

Balance Swap

18650 / 21000 Cell Charging

[VIDEO](#)

We highly recommend that you use either the **6A** or **12A**, 50.4V 12S LI ION BATTERY CHARGER pictured below and sold on our website.

Alternative chargers can also be used.*

*Please ensure you have read the manual for your specific charger and you are familiar with how to use the charger correctly before continuing. We hold **NO RESPONSIBILITY** for incorrect use of a charger.



6A Li-Ion Charger



12A Li-Ion Charger

Lithium Battery Voltages

	1 Cell (1S)	12 Cells (12S)
0%	3.00V	36.00V
Recommended minimum	3.35V	40.20V
Storage	3.80V	45.60V
100%	4.20V	50.40V

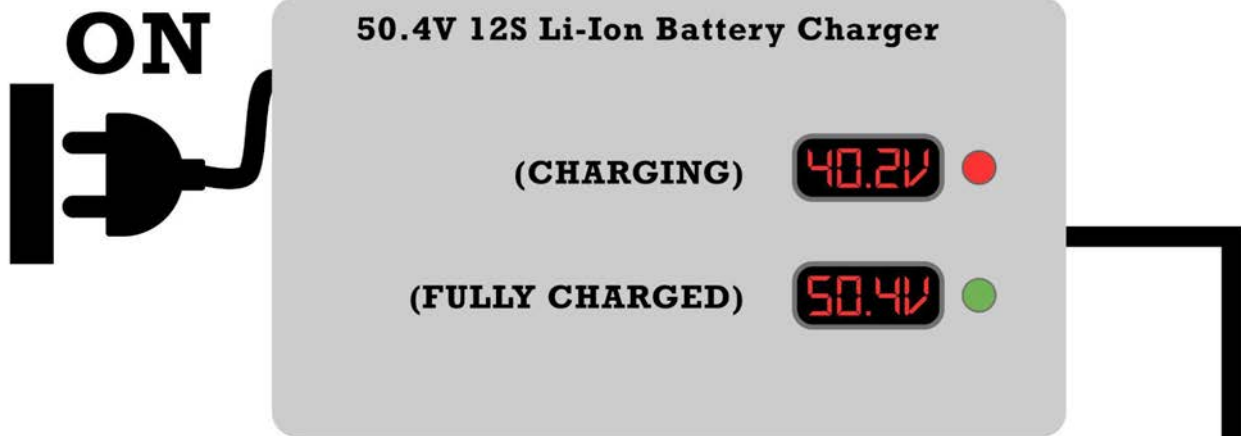

1. PLUG IN and TURN ON the CHARGER BEFORE connecting any batteries to the charger.
2. Remove the THUMB SCREW and INSPECTION PIT LID on the top of MONSTER BOX.
3. PLUG the XT30 EXTENSION from the charger into the XT30 inside the INSPECTION PIT.
4. The charger LED will change to RED (wait 5 seconds) and 12A chargers also display the battery's Voltage - Indicating the battery is now charging.
5. Once the battery is CHARGED the LED will be GREEN and the display will show 50.4V on the 12A chargers.
6. Unplug the XT30 connecting the charger to the board.
7. Place the LID back on ensuring no cables have been trapped.
8. Put the THUMB SCREW back on and tighten.
9. Turn OFF the CHARGER and UNPLUG from the wall.



Maintenance

Like any mechanical product, Trampa's Dirt-E-Trike requires maintenance to keep the board running smoothly, safely and at its best.

UNLESS OTHERWISE STATED PLEASE COMPLETE ALL MAINTENANCE WITH THE BOARD POWERED OFF!

We also recommend using a sturdy object to raise your rear wheels off the ground.

General

Tightening of Bolts - Bolts to Check!

Cleaning the Trike

When cleaning the Dirt-E-Trike it is important not to get the trike completely wet. AVOID getting any of the electronics or enclosures wet. While Trampa's Monster Box Enclosures can withstand splashes of water the electronics are NOT WATERPROOF.

We recommend removing any heavy material with a soft brush and to clean further with a damp cloth.

A toothbrush is ideal for getting into the smaller spaces and cleaning the motor pulleys.

DO NOT SUBMERGE!

DO NOT PRESSURE WASH or HOSE DOWN!

Drivetrain Health

If you suspect your drivetrain is having problems please see the specific section further in the manual.

Problems may include:

- The drivetrain has more or less rolling resistance compared to usual.
- Rough feeling or grating noise
- Reduced power or torque
- A belt is showing signs of wear or has snapped

Wheels

Changing a Tyre or Inner Tube

Front Wheels

1. Remove the Axle Nut using either a 14mm Spanner for 9.5mm axles or a 16mm Spanner for 12mm axles.
2. Remove the Wheel from the Axle.
3. Remove the valve dustcap and deflate the tyre using a sharp object or a T20 Screwdriver to press the valve in.
4. Using a T20 Screwdriver, remove the 6 M4 bolts on HYPAs Hubs, or the 5 M4 bolts on other hubs.
5. The hub can now be separated in two halves, leaving the tyre and innertube.
6. Remove the innertube from the inside of the tyre.
7. Check the inside and outside of the tyre for any objects which may have caused the puncture.
8. Replace the innertube with a new one and fill up with enough air for the innertube to take shape.
9. Follow Steps 5 to 1 to rebuild the wheel onto the board.

Rear Wheels

1. Remove the Axle Nut using either a 14mm Spanner for 9.5mm axles or a 16mm Spanner for 12mm axles.
2. Remove valve dustcap and deflate the tyre using a sharp object or a T20 Screwdriver to press the valve.
3. Using a T20 Screwdriver, remove the hub from the gear/pulley by taking out the 6 bolts M4 bolts on HYPAs Hubs, or the 5 M4 bolts on other hubs.
4. Remove the Wheel from the Axle.
5. If using PHATLAD Hubs, please remove the remaining bolts using a T20 Screwdriver.
6. The hub can now be separated in two halves, leaving the tyre and innertube.
7. Remove the innertube from the inside of the tyre.
8. Check the inside and outside of the tyre for any objects which may have caused the puncture.
9. Replace the innertube with a new one and fill up with enough air for the innertube to take shape.
10. Follow Steps 6 to 1 to rebuild the wheel onto the board.

Tyre Pressure

The recommended tire pressure is between 20 and 30psi. Incorrect tyre pressure can cause loss of grip or control. Always check the tire pressure of each wheel before riding.

Spur Gear Drive

[VIDEO](#)

Maintaining the Gears

Greasing of the gears is ESSENTIAL to the performance and longevity of the Spur Gear Drivetrain. Failure to maintain the SGD can result in accelerated wear of components and ultimately decreased performance and safety.

We recommend wearing protective gloves before getting started and using EP3 Lithium Grease for the gears.

1. Remove the Axle Nut using a 16mm Spanner..
2. Remove the Valve Dustcap and deflate the tyre using a sharp object to press the Valve.
3. Using a T20 Screwdriver, remove the hub from the drive by taking out the 6 bolts M4 bolts on HYPA Hubs, or the 5 bolts on other hubs.
4. Remove the Wheel from the Axle and put it to one side.
5. Remove the Rubber V-Ring Seal off between the Slave Gear and the Tub Cover.
6. Using a T20 Screwdriver remove the 4 M4 Cap bolts holding the Tub Cover onto Tub.
7. Remove the Slave Gear from the tub by sliding it along the axle.

If you are MAINTAINING the board - NOT if the drive is new.

8. Clean out all grease and buildup using a cloth or paper towels from the inside of the TUB, and off both slave and motor gears.
9. Inspect the Slave and Motor Gears for signs of wear. This may include chips in the gears, or the gear teeth being sharp.

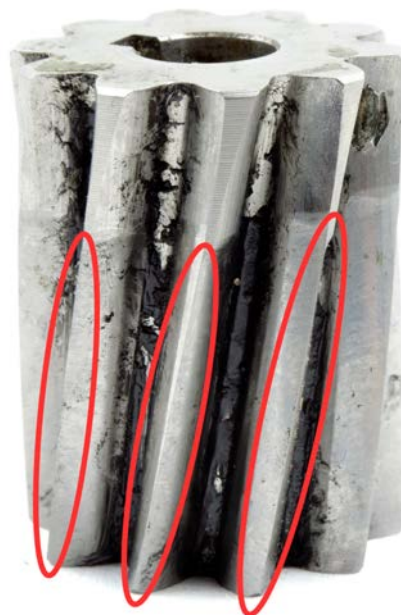

Worn / Sharp Motor Pulley

10. Apply new grease to the inside lip of the Tub, to all teeth of the Slave Gear and to all teeth of the Motor Gear.

Tips:

- Use quality lithium grease
- Apply an even coating about 1mm off the surface of all the teeth on the gears - See diagram below
- Use your finger to spin round the Motor Gear to ensure all teeth have an even coating.
- Apply an even coating approximately 8mm into the inside lip of the tub -See diagram below

11. Slide the Slave Pulley back onto the axle, aligning the teeth of the gears so that the Slave Gear rests inside the Tub.

12. Apply BLUE Loctite to the 4 M4x10 Cap Head Bolts which secured the Tub Cover on.

13. Align the Tub Cover with the Tub and use a T20 Screwdriver and the 4 M4 bolts to secure it.

14. Place the Rubber V-Ring back between the Slave Gear and Tub Cover.

15. Follow Steps 4 to 1 to rebuild the wheel onto the board.

16. Continue onto the section "Adjusting Backlash / Meshing of the Gears".

Adjusting Backlash/ Meshing of Gears

Tips -

- When loosening or tightening the M5 Hex Conical Clamp bolts please do so evenly to keep the drive for moving or twisting out of alignment.
1. Undo 4 M5 Hex Bolts using a 8mm Spanner holding the Conical Clamp onto the Hanger until the bolts are approximately 2 mm out.
 2. Check for movement in the SGD Tub.

Only follow this step if you have recently APPLIED GREASE to the GEARS

3. Spin the Wheel by hand in both directions to evenly displace the Grease between the Teeth.

REPEAT these Steps until the Gear Position is set correct

4. Push the Motor / Motor Filter in the direction of the Slave Pulley - meshing the gears together.
5. Grab the Motor by squeezing it through the Motor Filter
6. Rotate the Wheel and feel for around 1 mm of movement.
7. Move the Motor towards the the Slave Pulley to reduce movement
8. Move the Motor away from the Slave Pulley to increase movement
9. Rotate the Wheel and feel for around 1 mm of movement.

10. Hold the Motor in position and EVENLY tighten the M5 Hex Bolts using a 8mm Spanner, tighten the clamp and fix the drive in position.

Recommended check every 200 miles (10 rides avg)

Li-Ion & LiPo Battery Care & Safety information

PLEASE READ CAREFULLY

Lithium-Ion Battery Hazards

Lithium batteries have high energy densities. Lithium-ion & Lithium Polymer battery fire hazards are associated with the high energy densities coupled with the flammable organic electrolyte. This creates challenges for use, storage, and handling. Physical damage, electrical abuse such as short circuits and overcharging, exposures to elevated temperature, manufacturer's defects such as imperfections and or contaminants in the manufacturing process can all cause a thermal runaway. This means a rapid self-heating from a chemical reaction that can result in a chain reaction thermal runaway of adjacent cells. The reaction vaporises the organic electrolyte and pressurises the cell casing. If (or when) the case fails, the flammable and toxic gases within the cell are released resulting in combustion and the ignition of the cell(s).

With this in mind it is essential that you read carefully and fully understand the following information.

Li-Ion & LiPo Battery Usage

Procurement

- Purchase batteries from a reputable manufacturer or supplier.
- Avoid batteries shipped without protective packaging.
- Inspect batteries on receipt and safely dispose of damaged batteries.

Handling and Use

- Handle batteries and or battery-powered devices cautiously to not damage the battery casing or connections.
- Keep batteries away from contact with conductive materials, water, seawater, strong oxidizers and strong acids.
- Do not place batteries in direct sunlight, on hot surfaces or in hot locations.
- The cell must stay within the operating temperatures outlined in the cell data sheet
- inspect batteries for signs of damage before use. Never use damaged cells and promptly dispose of damaged or puffy batteries.
- Keep all flammable materials away from the battery operating area.
- Allow time for cooling before charging a battery that is still warm from usage.
- Allow a battery that is still warm from charging to cool before using.
- The cell must not exceed voltage, current, and other ratings in its data sheet.
- Be careful not to short circuit – this is when exposed terminals come into contact with metal objects or from poor wiring practices or abuse. Short circuits discharge very quickly and will heat the battery to high temperatures due to the high current flow.
- Do not keep in the sun in a hot car or anywhere with direct heat
- If you notice an unusual odour, rusty deformation, damaged surfaces or fluid discharge, especially on first use, discontinue use.
- Keep cells away from animals and children.
- If the cell is attached to a PCB, keep it away from high static environments.

Charging

- Use chargers or charging methods designed to charge in a safe manner li-ion cells or LiPo battery packs at the specified parameters.
- Before using a charger or electronic device, read their user manuals.
- Only charge in an area free from any material which can catch fire. The ideal surface for charging batteries is concrete or ceramic.
- Charge and store batteries in a fire-retardant container when practical.
- Only use the charging method Constant Voltage/ Constant Current CVCC. (The charger limits the amount of current to a pre-set level until the battery reaches a pre-set voltage level. The current then reduces as the battery becomes fully charged).
- Confirm terminals are aligned correctly before inserting cell into charger or device
- Do not exceed either the max charge voltage or max current voltage or charge operating temperatures. Overcharge is greater than 4.2V for most batteries or over-discharge (below 3V) batteries.
- Do not charge near high temperatures or flammable materials.
- Discontinue charging after exceeding charge time outlined in the user manual or data sheet.
- Disconnect batteries immediately if, during operation or charging, they emit an unusual smell, develop heat, change shape/geometry, or behave abnormally. Dispose of the batteries.
- Do not parallel charge batteries of varying age and charge status; chargers cannot monitor the current of individual cells and initial voltage balancing can lead to high amperage, battery damage, and heat generation. Check voltage before parallel charging; all batteries should be within 0.5 Volts of each other.
- If the cell does not increase its charge after a prolonged time in the charger, discontinue use and dispose of the cell.
- Your charger or device should have a warning for over voltage, over current and over temperature, and should also have a control of overcharge and charge timer.
- Remove cells and pack from chargers promptly after charging is complete. Do not use the charger as a storage location.
- Never charge a primary one time use battery.
- Never charge with a cigarette lighter charger or directly by electrical outlet.

Discharging

- Discharge within the recommended temperature range (between -20°C and +60°C)
- Do not exceed maximum continuous discharge current, as detailed in the cell data sheet.
- Do not discharge below 3.0V per cell. Over discharge can damage battery performance
- When nominal capacity after full discharge cycle is less than 80% of rated capacity, discontinue use.

Storage

- Store batteries away from combustible materials.
- If practical, store batteries in a fire-retardant container.
- Store the batteries at temperatures between 5°C and 20°C (41°F and 68°F).
- Separate fresh and depleted cells (or keep a log).
- Store one-time use batteries separately from rechargeable batteries.
- Visually inspect the battery in storage weekly.
- Charge batteries in storage to approximately 30-50% of capacity at least once every six months.
- Charge or discharge the battery to approximately 30-50% of capacity before long-term storage.

Disposal

- Dispose of damaged cells and cells that no longer hold a substantial charge. To check the general condition of your cells, charge them, let them rest for an hour, then measure the voltage. If your cells are close to 4.2V, the cells are in good condition.
- Dispose of used batteries by following proper disposal protocols and taking them to a household e-waste collection point or battery-recycling drop off location.
- Cover terminals with insulating tape before disposal

Prohibited

- Do not exceed any of the rated specifications
- Do not charge or discharge near flammable materials or gas
- Do not leave to charge unattended, if a battery becomes puffy, smokes or catches fire you need to be able to immediately handle the situation. Walking away for just 5 minutes can spell disaster.
- Do not let batteries get wet or submerged
- Do not allow the positive or negative poles to connect with conductive materials
- Do not reverse polarity
- Do not insert insulation or other objects between the metal plate, cell or other components
- Do not overheat or overload
- Do not mix different battery brands or models
- Do not solder directly on the cell
- Do not touch a leaking cell
- Do not throw, puncture, or incinerate
- Do not ingest

What to do in an Emergency

Follow these steps if there is evidence of a battery malfunction (e.g. swelling, heating, or irregular odours).

- Use personal protective equipment, such as gloves, goggles/safety glasses and lab coat.
- If batteries are showing evidence of thermal runaway failure, be very cautious because the gases may be flammable and toxic and failure modes can be hazardous.
- Disconnect the battery (if possible).
- Remove the battery from the equipment/device (if possible).
- Place the battery in a metal or other container away from combustibles.
- Contact the local fire department and ask for advice on how to proceed.
- If a lithium battery fire occurs, use a CO₂ (Class BC) or Dry Powder (Class ABC) fire extinguisher. Lithium batteries do not have actual lithium metal so do not use a Class D fire extinguisher.

Please note:

Because batteries utilise a chemical reaction, battery performance will deteriorate over time even if stored for long periods without use. The performance and life expectancy of batteries depends heavily on usage conditions such as charge, discharge and ambient temperature, if the batteries are not maintained within the specified ranges then the life expectancy of the battery will be shortened.

Warranty Policy

Trampa Boards Ltd. goods and services are supplied in accordance with our Standard Terms and Conditions. This policy sets out the Warranty Period and exclusions which apply to all products purchased from the Trampa Boards Ltd. website. This policy is subject to our Standard Terms and Conditions and should be read in conjunction with those terms, particularly clause 5 of the Terms and Conditions.

Warranty

Subject to the exclusions set out below and in Clause 5 of the Terms and Conditions, faulty parts, products and workmanship will be replaced or repaired free of charge by Trampa Boards Ltd, or its Distributor or Service Provider where such faults arise during the applicable Warranty Period.

Claims

- If the claim is justified, the product(s) or part(s) will be repaired or replaced or a credit issued. It is our policy to replace parts wherever possible.
- Trampa Boards Ltd will pay for the shipping expenses, Trampa Boards Ltd can charge for returned products that are not found to be defective or non-conforming, in addition to associated shipping, test and handling costs.

Warranty Periods

This warranty is limited to a period of 180 days from the date of purchase.

*Spare parts are warrantied for 180 days where fitted to the manufacturer's instructions and specifications and subject to the Terms and Conditions.

Exclusions:

1. This policy only applies where
 - i) The product is installed and used strictly in accordance with the Terms and Conditions and the instructions supplied with the product, and
 - ii) The failure is not due to accident, misuse, abuse, negligence, accidents, unsuitable water conditions, or to any alteration, modification, repair by any party not expressly nominated by Trampa Boards Ltd.
2. This warranty does not cover damage resulting from non-operation of the product or consequential damage to any other goods, furnishings or property.
3. This warranty does not cover any wear and tear of perishable items or damages incurred during assembly or maintenance.
4. This warranty does not cover damages incurred during transportation.
5. This warranty does not cover buyer's remorse.
6. This warranty does not cover theft or loss of the product.
7. This warranty does not cover inappropriate use such as entering competitions, races, exhibitions, or commercial events. Trampa Boards Ltd. products are not designed to be used to do jumps and stunts.

Claim Procedure

- Claims for defective merchandise must be made to Trampa Boards (support@trampaboards.com) within 180 days from the invoice date. Claims for missing parts must be made within 30 calendar days after the merchandise is received.
- Any claims for defective merchandise returns must be returned according to our returns policy**
- We reserve the right to specify that items be returned to Trampa HQ in Nottingham, UK for inspection.
- Details of the defective product with accompanying pictures (and videos if possible) are required to claim defective merchandise along with a copy of the original invoice.
- For products purchased anywhere other than the Trampa Boards website, please revert back to your supplier.

Service Work:

Ad hoc repairs by Trampa Boards Ltd. are covered under Warranty for 30 days in relation to the original fault only.

**Returns Policy

Trampa Boards Ltd do not accept return deliveries unless we have:

- i) authorised the return and
- ii) sent you a return label to use. Trampa Boards Ltd reserves the right to charge for any costs incurred by customers not following the Returns Policy guidance.

SEE NEXT PAGE

Contact

Our emails are checked regularly, however if your problem is urgent or you feel you need to speak to us in person then please WhatsApp or call 7am - 4pm, Monday - Saturday. Please remember if you are not in the UK then there is a time difference to consider.

Email: support@trampboards.com

Phone: 0044 7734 905883

Website: trampboards.com

Address:

We DO NOT ACCEPT RETURNS without first speaking with our customer support team.

Trampa Boards
Unit 16, Centre Court
33 Little Tennis Street
Colwick, Nottingham
NG2 4EL, United Kingdom